

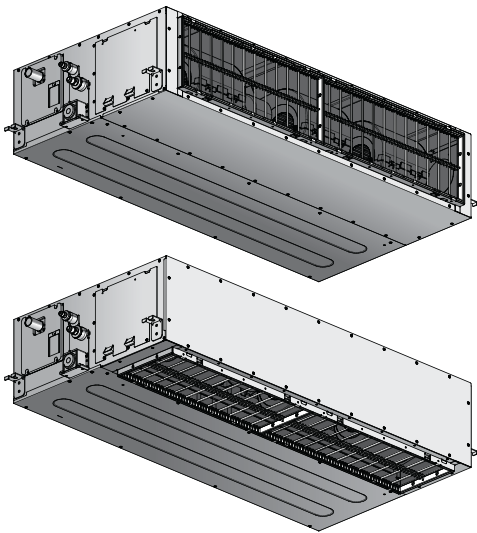

Installation and operation manual

Split system air conditioners



FDA125A5VEB

Installation and operation manual
Split system air conditioners

English

EU - Svrhová deklarácia o súlade s normami
EU - Sachverhalts Konformitätsklärung
EU - Déclaration de conformité de sécurité
EU - Conformitätsklärung und veiligheid

EU - Varnostna izjava o skladnosti
EU - Ohuusa vastavusdeklaratsioon
EU - Декларация о соответствии с безопасностью
AB - Goveinik upjunikut bejani

EU - Izjava o skladnosti za sigurnost
EU - Bitchonsaji megjelöléségi nyilatkozás
UE - Déclaration d'opinion sur l'absence de danger
UE - Declaratie de conformitate de siguranță

EU - Svrhsverskijaring for sikkerhed
EU - Turvallisuuden vaatimustenmukaisuusvaikutus
EU - Верадносч протхашен о стобде
UE - Declaratie de conformitate de siguranță

EU - Zavedenie o sovetstviy trebovaniya po bezopasnosti
EU - Sikkerheds-overensstemmelseserklaring
EU - Konformitatsdeklaration for sikkerhet

EU - Declaración de conformidad sobre seguridad
EU - Dichiarazione di conformità in materia di sicurezza
EU - Δήλωση συμμόρφωσης για την ασφάλεια
EU - Declarație de conformitate relativă a siguranță

EU - Svrhová deklarácia o bezpečnosti
EU - Sachverhalts Konformitätsklärung
EU - Déclaration de conformité de sécurité
EU - Conformitätsklärung und veiligheid

EU - Varnostna izjava o skladnosti
EU - Ohuusa vastavusdeklaratsioon
EU - Декларация о соответствии с безопасностью
AB - Goveinik upjunikut bejani

EU - Izjava o skladnosti za sigurnost
EU - Bitchonsaji megjelöléségi nyilatkozás
UE - Déclaration d'opinion sur l'absence de danger
UE - Declaratie de conformitate de siguranță

EU - Svrhsverskijaring for sikkerhed
EU - Turvallisuuden vaatimustenmukaisuusvaikutus
EU - Верадносч протхашен о стобде
UE - Declaratie de conformitate de siguranță

EU - Svrhová deklarácia o bezpečnosti
EU - Sachverhalts Konformitätsklärung
EU - Déclaration de conformité de sécurité
EU - Conformitätsklärung und veiligheid

EU - Zavedenie o sovetstviy trebovaniya po bezopasnosti
EU - Sikkerheds-overensstemmelseserklaring
EU - Konformitatsdeklaration for sikkerhet

EU - Declaración de conformidad sobre seguridad
EU - Dichiarazione di conformità in materia di sicurezza
EU - Δήλωση συμμόρφωσης για την ασφάλεια
EU - Declarație de conformitate relativă a siguranță

EU - Svrhová deklarácia o bezpečnosti
EU - Sachverhalts Konformitätsklärung
EU - Déclaration de conformité de sécurité
EU - Conformitätsklärung und veiligheid

EU - Svrhová deklarácia o bezpečnosti
EU - Sachverhalts Konformitätsklärung
EU - Déclaration de conformité de sécurité
EU - Conformitätsklärung und veiligheid

FDA 125A5VEB,

01 02 03 04 05 06 07 08

01 02 03 04 05 06 07 08

01 02 03 04 05 06 07 08

01 02 03 04 05 06 07 08

01 02 03 04 05 06 07 08

01 02 03 04 05 06 07 08

01 02 03 04 05 06 07 08

01 02 03 04 05 06 07 08

01 02 03 04 05 06 07 08

01 02 03 04 05 06 07 08

01 02 03 04 05 06 07 08

01 02 03 04 05 06 07 08

01 02 03 04 05 06 07 08

01 02 03 04 05 06 07 08

01 02 03 04 05 06 07 08

01 02 03 04 05 06 07 08

01 02 03 04 05 06 07 08

01 02 03 04 05 06 07 08

01 02 03 04 05 06 07 08

01 02 03 04 05 06 07 08

01 02 03 04 05 06 07 08

01 02 03 04 05 06 07 08

01 02 03 04 05 06 07 08

01 02 03 04 05 06 07 08

01 02 03 04 05 06 07 08

01 02 03 04 05 06 07 08

01 02 03 04 05 06 07 08

01 02 03 04 05 06 07 08

01 02 03 04 05 06 07 08

01 02 03 04 05 06 07 08

01 02 03 04 05 06 07 08

01 02 03 04 05 06 07 08

01 02 03 04 05 06 07 08

01 02 03 04 05 06 07 08

01 02 03 04 05 06 07 08

01 02 03 04 05 06 07 08

01 02 03 04 05 06 07 08

01 02 03 04 05 06 07 08

01 02 03 04 05 06 07 08

01 02 03 04 05 06 07 08

01 02 03 04 05 06 07 08

01 02 03 04 05 06 07 08

01 02 03 04 05 06 07 08

01 02 03 04 05 06 07 08

01 02 03 04 05 06 07 08

01 02 03 04 05 06 07 08

01 02 03 04 05 06 07 08

01 02 03 04 05 06 07 08

UKCA – Safety declaration of conformity

Daikin Europe N.V.

declares under its sole responsibility that the products to which this declaration relates:

FDA125A5VEB,

are in conformity with the following directive(s) or regulation(s), provided that the products are used in accordance with our instructions:

- S.I. 2008/1597: Supply of Machinery (Safety) Regulations 2008**
- S.I. 2016/1101: Electrical Equipment (Safety) Regulations 2016
- S.I. 2016/1091: Electromagnetic Compatibility Regulations 2016*

as amended,

following the provisions of: BS EN 60335-2-40,

* as set out in <A> and judged positively by according to the **Certificate <C>**.

** Daikin Europe N.V. is authorised to compile the Technical Construction File.

<A>	DAIKIN.TCF.033A4/04-2017
	—
<C>	—



Table of Contents

1	About the documentation	4
1.1	About this document.....	4
2	Specific installer safety instructions	5
For the user 6		
3	User safety instructions	6
3.1	General.....	6
3.2	Instructions for safe operation.....	7
4	About the system	9
4.1	System layout.....	9
5	User interface	9
6	Operation	9
6.1	Operation range.....	9
6.2	About operation modes.....	10
6.2.1	Basic operation modes.....	10
6.2.2	Special heating operation modes.....	10
6.3	To operate the system.....	10
7	Maintenance and service	10
7.1	Precautions for maintenance and service.....	10
7.2	Cleaning the air filter and air outlet.....	10
7.2.1	To clean the air filter.....	10
7.2.2	To clean the air outlet.....	11
7.3	About the refrigerant.....	11
8	Troubleshooting	11
9	Relocation	12
10	Disposal	12
For the installer 12		
11	About the box	12
11.1	Indoor unit.....	12
11.1.1	To remove the accessories from the indoor unit.....	12
12	Unit installation	12
12.1	Preparing the installation site.....	12
12.1.1	Installation site requirements of the indoor unit.....	12
12.2	Mounting the indoor unit.....	13
12.2.1	Guidelines when installing the indoor unit.....	13
12.2.2	Guidelines when installing the ducting.....	14
12.2.3	Guidelines when installing the drain piping.....	14
13	Piping installation	16
13.1	Preparing refrigerant piping.....	16
13.1.1	Refrigerant piping requirements.....	16
13.1.2	Refrigerant piping insulation.....	16
13.2	Connecting the refrigerant piping.....	16
13.2.1	To connect the refrigerant piping to the indoor unit.....	16
14	Electrical installation	17
14.1	Specifications of standard wiring components.....	17
14.2	To connect the electrical wiring to the indoor unit.....	17
15	Commissioning	18
15.1	Checklist before commissioning.....	19
15.2	To perform a test run.....	19
16	Configuration	19
16.1	Field setting.....	19

17	Technical data	20
17.1	Wiring diagram.....	20
17.1.1	Unified wiring diagram legend.....	20

1 About the documentation

1.1 About this document



WARNING

Make sure installation, servicing, maintenance, repair and applied materials follow the instructions from Daikin (including all documents listed in “Documentation set”) and, in addition, comply with applicable legislation and are performed by qualified persons only. In Europe and areas where IEC standards apply, EN/IEC 60335-2-40 is the applicable standard.



INFORMATION

Make sure that the user has the printed documentation and ask him/her to keep it for future reference.

Target audience

Authorised installers + end users



INFORMATION

This appliance is intended to be used by expert or trained users in shops, in light industry, and on farms, or for commercial and household use by lay persons.

Documentation set

This document is part of a documentation set. The complete set consists of:

- **General safety precautions:**
 - Safety instructions that you must read before installing
 - Format: Paper (in the box of the indoor unit)
- **Indoor unit installation and operation manual:**
 - Installation and operation instructions
 - Format: Paper (in the box of the indoor unit)
- **Installer and user reference guide:**
 - Preparation of the installation, good practices, reference data,...
 - Detailed step-by-step instructions and background information for basic and advanced usage
 - Format: Digital files on <https://www.daikin.eu>. Use the search function  to find your model.

Latest revisions of the supplied documentation may be available on the regional Daikin website or via your dealer.

Scan the QR code below to find the full documentation set and more information about your product on Daikin website.



The original documentation is written in English. All other languages are translations.

Technical engineering data

- A **subset** of the latest technical data is available on the regional Daikin website (publicly accessible).
- The **full set** of latest technical data is available on the Daikin Business Portal (authentication required).

2 Specific installer safety instructions

Always observe the following safety instructions and regulations.

General



WARNING

Make sure installation, servicing, maintenance, repair and applied materials follow the instructions from Daikin (including all documents listed in "Documentation set") and, in addition, comply with applicable legislation and are performed by qualified persons only. In Europe and areas where IEC standards apply, EN/IEC 60335-2-40 is the applicable standard.

Unit installation (see "12 Unit installation" ▶ 12)



WARNING

Installation shall be done by an installer, the choice of materials and installation shall comply with the applicable legislation. In Europe, EN378 is the applicable standard.



WARNING

The appliance using R32 refrigerant shall be stored so as to prevent mechanical damage and in a well-ventilated room without continuously operating ignition sources (e.g. open flames, an operating gas appliance, or an operating electric heater). The room size shall be as specified in the General safety precaution.



CAUTION

Appliance NOT accessible to the general public. Install it in a secured area, protected from easy access.

This unit is suitable for installation in a commercial, light industrial, household and residential environment.



WARNING

For units using the R32 refrigerant it is necessary to keep any required ventilation openings clear of obstructions.

Duct installation (see "12.2.2 Guidelines when installing the ducting" ▶ 14)



WARNING

Do NOT install operating ignition sources (example: open flames, an operating gas appliance or an operating electric heater) in the duct work.



CAUTION

- Make sure the installation of the duct does NOT exceed the setting range of the external static pressure for the unit. Refer to the technical datasheet of your model for the setting range.
- Make sure to install the canvas duct so vibrations are NOT transmitted to the duct or ceiling. Use a sound-absorbing material (insulation material) for the lining of the duct and apply vibration insulation rubber to the hanging bolts.
- When welding, make sure NOT to spatter onto the drain pan or the air filter.
- If the metal duct passes through a metal lath, wire lath or metal plate of the wooden structure, separate the duct and wall electrically.
- Install the outlet grille in a position where the airflow will not come into direct contact with people.
- Do NOT use booster fans in the duct. Use the function to adjust the fan rate setting automatically (see "16 Configuration" ▶ 19).

Refrigerant piping installation (see "13 Piping installation" ▶ 16)



CAUTION

- Incomplete flaring may cause refrigerant gas leakage.
- Do NOT re-use flares. Use new flares to prevent refrigerant gas leakage.
- Use flare nuts that are included with the unit. Using different flare nuts may cause refrigerant gas leakage.



CAUTION

Piping MUST be installed according to instructions given in "13 Piping installation" ▶ 16. Only mechanical joints (e.g. braze+flare connections) that are compliant with the latest version of ISO14903 can be used.



CAUTION

Install the refrigerant piping or components in a position where they are unlikely to be exposed to any substance which may corrode components containing refrigerant, unless the components are constructed of materials that are inherently resistant to corrosion or are suitably protected against corrosion.

Electrical installation (see "14 Electrical installation" ▶ 17)



WARNING

ALWAYS use multicore cable for power supply cables.



WARNING

- All wiring MUST be performed by an authorised electrician and MUST comply with the applicable national wiring regulation.
- Make electrical connections to the fixed wiring.
- All components procured on-site and all electrical construction MUST comply with the applicable legislation.

3 User safety instructions

WARNING

- If the power supply has a missing or wrong N-phase, equipment might break down.
- Establish proper earthing. Do NOT earth the unit to a utility pipe, surge absorber, or telephone earth. Incomplete earthing may cause electrical shock.
- Install the required fuses or circuit breakers.
- Secure the electrical wiring with cable ties so that the cables do NOT come in contact with sharp edges or piping, particularly on the high-pressure side.
- Do NOT use taped wires, extension cords, or connections from a star system. They can cause overheating, electrical shock or fire.
- Do NOT install a phase advancing capacitor, because this unit is equipped with an inverter. A phase advancing capacitor will reduce performance and may cause accidents.

WARNING

Use an all-pole disconnection type breaker with at least 3 mm between the contact point gaps that provides full disconnection under overvoltage category III.

WARNING

If the supply cord is damaged, it MUST be replaced by the manufacturer, its service agent or similarly qualified persons in order to avoid a hazard.

For the user

3 User safety instructions

Always observe the following safety instructions and regulations.

3.1 General

WARNING

If you are NOT sure how to operate the unit, contact your installer.

WARNING

This appliance can be used by children aged from 8 years and above and persons with reduced physical, sensory or mental capabilities or lack of experience and knowledge if they have been given supervision or instruction concerning use of the appliance in a safe way and understand the hazards involved.

Children SHALL NOT play with the appliance.

Cleaning and user maintenance SHALL NOT be made by children without supervision.

WARNING

To prevent electrical shocks or fire:

- Do NOT rinse the unit.
- Do NOT operate the unit with wet hands.

- Do NOT place any objects containing water on the unit.

CAUTION

- Do NOT place any objects or equipment on top of the unit.
- Do NOT sit, climb or stand on the unit.

- Units are marked with the following symbol:



This means that electrical and electronic products may NOT be mixed with unsorted household waste. Do NOT try to dismantle the system yourself: dismantling the system, treatment of the refrigerant, of oil and of other parts MUST be done by an authorised installer and MUST comply with applicable legislation.

Units MUST be treated at a specialised treatment facility for reuse, recycling and recovery. By ensuring this product is disposed of correctly, you will help to prevent potential negative consequences for the environment and human health. For more information, contact your installer or local authority.

- Batteries are marked with the following symbol:



This means that the batteries may NOT be mixed with unsorted household waste. If a chemical symbol is printed beneath the symbol, this chemical symbol means that the battery contains a heavy metal above a certain concentration.

Possible chemical symbols are: Pb: lead (>0.004%).

Waste batteries MUST be treated at a specialised treatment facility for reuse. By ensuring waste batteries are disposed of correctly, you will help to prevent potential negative consequences for the environment and human health.

3.2 Instructions for safe operation

WARNING

- Do NOT modify, disassemble, remove, reinstall or repair the unit yourself as incorrect dismantling or installation may cause an electrical shock or fire. Contact your dealer.
- In case of accidental refrigerant leaks, make sure there are no naked flames. The refrigerant itself is entirely safe and non-toxic. R410A is a non-combustible refrigerant, and R32 is a mildly flammable refrigerant, but they will generate a toxic gas when they accidentally leak into a room where combustible air from fan heaters, gas cookers, etc. is present. Always have qualified service personnel confirm that the point of leakage has been repaired or corrected before resuming operation.

CAUTION

- NEVER touch the internal parts of the controller.
- Do NOT remove the front panel. Some parts inside are dangerous to touch and appliance problems may happen. For checking and adjusting the internal parts, contact your dealer.

WARNING

This unit contains electrical and hot parts.

WARNING

Before operating the unit, be sure the installation has been carried out correctly by an installer.

CAUTION

It is unhealthy to expose your body to the air flow for a long time.

CAUTION

To avoid oxygen deficiency, ventilate the room sufficiently if equipment with burner is used together with the system.

CAUTION

Do NOT operate the system when using a room fumigation-type insecticide. Chemicals could collect in the unit, and endanger the health of people who are hypersensitive to chemicals.

WARNING

NEVER touch the air outlet or the horizontal blades while the swing flap is in operation. Fingers may become caught or the unit may break down.

CAUTION

NEVER expose little children, plants or animals directly to the airflow.

WARNING

Do NOT place a flammable spray bottle near the air conditioner and do NOT use sprays near the unit. Doing so may result in a fire.

WARNING

For units using the R32 refrigerant it is necessary to keep any required ventilation openings clear of obstructions.

Maintenance and service (see "[7 Maintenance and service](#)" [p 10])

CAUTION: Pay attention to the fan!

It is dangerous to inspect the unit while the fan is running.

Make sure to turn OFF the main switch before executing any maintenance task.

CAUTION

Do NOT insert fingers, rods or other objects into the air inlet or outlet. When the fan is rotating at high speed, it will cause injury.

WARNING

NEVER replace a fuse with a fuse of a wrong ampere ratings or other wires when a fuse blows out. Use of wire or copper wire may cause the unit to break down or cause a fire.

3 User safety instructions

CAUTION

After a long use, check the unit stand and fitting for damage. If damaged, the unit may fall and result in injury.

CAUTION

Before accessing terminal devices, make sure to interrupt all power supply.

DANGER: RISK OF ELECTROCUTION

To clean the air conditioner or air filter, be sure to stop operation and turn all power supplies OFF. Otherwise, an electrical shock and injury may result.

WARNING

Be careful with ladders when working in high places.

DANGER: RISK OF ELECTROCUTION

Disconnect the power supply for more than 10 minutes, and measure the voltage at the terminals of main circuit capacitors or electrical components before servicing. The voltage **MUST** be less than 50 V DC before you can touch electrical components. For the location of the terminals, see the warning label for persons performing service and maintenance.

CAUTION

Turn off the unit before cleaning the unit exterior, air filter and suction grille.

WARNING

Do NOT let the indoor unit get wet.
Possible consequence: Electrical shock or fire.

About the refrigerant (see "[7.3 About the refrigerant](#)" ▶ 11)

WARNING: MILDLY FLAMMABLE MATERIAL

The R32 refrigerant (if applicable) in this unit is mildly flammable. Refer to the outdoor unit specifications for the type of refrigerant to be used.

WARNING

The appliance using R32 refrigerant shall be stored so as to prevent mechanical damage and in a well-ventilated room without continuously operating ignition sources (e.g. open flames, an operating gas appliance, or an operating electric heater). The room size shall be as specified in the General safety precaution.

WARNING

- Do NOT pierce or burn refrigerant cycle parts.
- Do NOT use cleaning materials or means to accelerate the defrosting process other than those recommended by the manufacturer.
- Be aware that the refrigerant inside the system is odourless.

WARNING

- R410A is a non-combustible refrigerant, and R32 is a mildly flammable refrigerant; they normally do NOT leak. If the refrigerant leaks in the room and comes into contact with fire from a burner, a heater, or a cooker, this may result in a fire (in case of R32), or the formation of a harmful gas.
- Turn OFF any combustible heating devices, ventilate the room, and contact the dealer from where you purchased the unit.
- Do NOT use the unit until a service person confirms that the part from which the refrigerant leaked has been repaired.

Troubleshooting (see "[8 Troubleshooting](#)" ▶ 11)

WARNING

Stop operation and shut OFF the power if anything unusual occurs (burning smells etc.).

Leaving the unit running under such circumstances may cause breakage, electrical shock or fire. Contact your dealer.

4 About the system

! WARNING

- Do NOT modify, disassemble, remove, reinstall or repair the unit yourself as incorrect dismantling or installation may cause an electrical shock or fire. Contact your dealer.
- In case of accidental refrigerant leaks, make sure there are no naked flames. The refrigerant itself is entirely safe and non-toxic. R410A is a non-combustible refrigerant, and R32 is a mildly flammable refrigerant, but they will generate a toxic gas when they accidentally leak into a room where combustible air from fan heaters, gas cookers, etc. is present. Always have qualified service personnel confirm that the point of leakage has been repaired or corrected before resuming operation.

! NOTICE

Do NOT use the system for other purposes. In order to avoid any quality deterioration, do NOT use the unit for cooling precision instruments, food, plants, animals, or works of art.

! NOTICE

For future modifications or expansions of your system:

A full overview of allowable combinations (for future system extensions) is available in technical engineering data and should be consulted. Contact your installer to receive more information and professional advice.

4.1 System layout

i INFORMATION

The following figures are just examples and may NOT completely match your system layout.

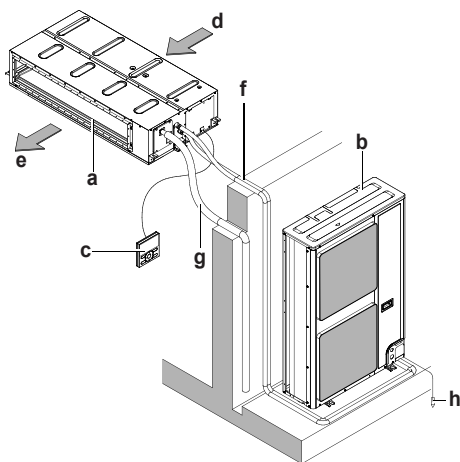

- a Indoor unit
- b Outdoor unit
- c User interface
- d Suction air
- e Discharge air
- f Refrigerant piping + interconnection cable
- g Drain pipe
- h Earth wiring

5 User interface

! CAUTION

- NEVER touch the internal parts of the controller.
- Do NOT remove the front panel. Some parts inside are dangerous to touch and appliance problems may happen. For checking and adjusting the internal parts, contact your dealer.

! NOTICE

Do NOT wipe the controller operation panel with benzine, thinner, chemical dust cloth, etc. The panel may get discoloured or the coating peeled off. If it is heavily dirty, soak a cloth in water-diluted neutral detergent, squeeze it well and wipe the panel clean. Wipe it with another dry cloth.

! NOTICE

NEVER press the button of the user interface with a hard, pointed object. The user interface may be damaged.

! NOTICE

NEVER pull or twist the electric wire of the user interface. It may cause the unit to malfunction.

This operation manual offers a non-exhaustive overview of the main functions of the system.

For more information about the user interface, see the operation manual of the installed user interface.

6 Operation

6.1 Operation range

For combination with R410A outdoor unit			
Outdoor units	Temperature	Cooling	Heating
RZQ250	Outdoor	-5~46°C DB	-15~15°C WB
	Indoor	14~28°C WB	10~27°C DB
RZQG125	Outdoor	-15~50°C DB	-20~15.5°C WB
	Indoor	12~28°C WB	10~27°C DB
RZQSG125	Outdoor	-15~46°C DB	-15~15.5°C WB
	Indoor	14~28°C WB	10~27°C DB
RR125	Outdoor	-15~46°C DB	—
	Indoor	12~28°C WB	—
RQ125	Outdoor	-5~46°C DB	-10~15°C WB
	Indoor	12~28°C WB	10~27°C DB
Indoor humidity		≤80% ^(a)	

^(a) To avoid condensation and water dripping out of the unit. If the temperature or the humidity is beyond these conditions, safety devices may be put in action and the air conditioner may not operate.

For combination with R32 outdoor unit			
Outdoor units	Temperature	Cooling	Heating
RZAG125	Outdoor	-20~52°C DB	-20~24°C DB -20~18°C WB
	Indoor	17~38°C DB 12~28°C WB	10~27°C DB

7 Maintenance and service

For combination with R32 outdoor unit			
Outdoor units	Temperature	Cooling	Heating
RZASG125	Outdoor	-15~46°C DB	-15~21°C DB -15~15.5°C WB
	Indoor	20~38°C DB 14~28°C WB	10~27°C DB
Indoor humidity		≤80% ^(a)	

^(a) To avoid condensation and water dripping out of the unit. If the temperature or the humidity is beyond these conditions, safety devices may be put in action and the air conditioner may not operate.

6.2 About operation modes





INFORMATION

Depending on the installed system, some operation modes will not be available.

- The air flow rate may adjust itself depending on the room temperature or the fan may stop immediately. This is not a malfunction.
- If the main power supply is turned off during operation, operation will restart automatically after the power turns back on again.
- **Setpoint.** Target temperature for the Cooling, Heating, and Auto operation modes.
- **Setback.** A function that keeps the room temperature in a specific range when the system is turned off (by the user, the schedule function, or the OFF timer).

6.2.1 Basic operation modes

The indoor unit can operate in various operation modes.

Icon	Operation mode
	Cooling. In this mode, cooling will be activated as required by the setpoint, or by Setback operation.
	Heating. In this mode, heating will be activated as required by the setpoint, or by Setback operation.
	Fan only. In this mode, air circulates without heating or cooling.
	Auto. In Auto mode, the indoor unit automatically switches between heating and cooling mode, as required by the setpoint.
	

6.2.2 Special heating operation modes

Operation	Description
Defrost	<p>To prevent a loss of heating capacity due to frost accumulation in the outdoor unit, the system will automatically switch to defrost operation.</p> <p>During defrost operation, the indoor unit fan will stop operation, and the following icon will appear on the home screen:</p>  <p>The system will resume normal operation after approximately 6 to 8 minutes.</p>

Operation	Description
Hot start	<p>During hot start, the indoor unit fan will stop operation, and the following icon will appear on the home screen:</p> 

6.3 To operate the system

INFORMATION

For setting of the operation mode or other settings, see the reference guide or operation manual of the user interface.

7 Maintenance and service

7.1 Precautions for maintenance and service

CAUTION

See "3 User safety instructions" [▶ 6] to acknowledge all related safety instructions.

NOTICE

NEVER inspect or service the unit by yourself. Ask a qualified service person to perform this work. However, as end user, you may clean the air filter and air outlet.

NOTICE

Maintenance MUST be done by an authorised installer or service agent.

We recommend performing maintenance at least once a year. However, applicable legislation might require shorter maintenance intervals.

NOTICE

Do NOT wipe the controller operation panel with benzine, thinner, chemical dust cloth, etc. The panel may get discoloured or the coating peeled off. If it is heavily dirty, soak a cloth in water-diluted neutral detergent, squeeze it well and wipe the panel clean. Wipe it with another dry cloth.

7.2 Cleaning the air filter and air outlet

CAUTION

Turn off the unit before cleaning the air filter and air outlet.

NOTICE

- Do NOT use gasoline, benzene, thinner polishing powder or liquid insecticide. **Possible consequence:** Discoloration and deformation.
- Do NOT use water or air of 50°C or higher. **Possible consequence:** Discoloration and deformation.

7.2.1 To clean the air filter

When to clean the air filter:

- Rule of thumb: Clean every 6 months. If the air in the room is extremely contaminated, increase the cleaning frequency.
- Depending on the settings, the user interface can display the **TIME TO CLEAN AIR FILTER** notification. Clean the air filter when the notification is displayed.

- If the dirt becomes impossible to clean, change the air filter (= optional equipment).

How to clean the air filter:

- 1 Remove the air filters by pulling their cloth upward (in case of rear suction) or backward (in case of bottom suction).

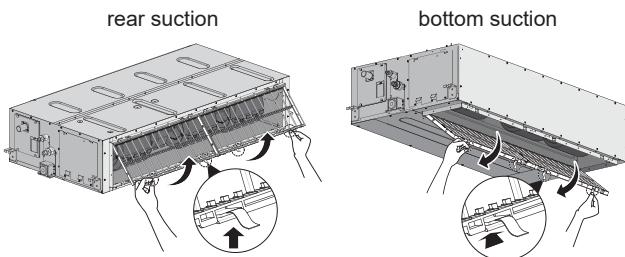

- 2 Clean the air filter. Use a vacuum cleaner or wash with water. If the air filter is very dirty, use a soft brush and neutral detergent.

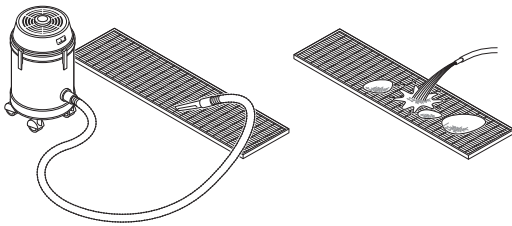

- 3 Dry the air filter in the shadow.
- 4 Reattach the air filter. Align the 2 hanger brackets and push the 2 clips in their place and pull the cloth if necessary.

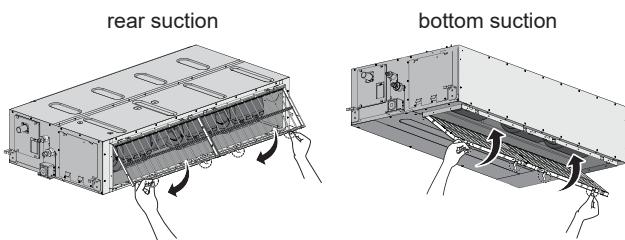

- 5 Confirm that 4 hangers are fixed.
- 6 In case of bottom suction, close the air inlet grille.
- 7 Turn ON the power.
- 8 Press the **FILTER SIGN RESET** button.

Result: The **TIME TO CLEAN AIR FILTER** notification disappears from the user interface.

7.2.2 To clean the air outlet



WARNING

Do NOT let the indoor unit get wet. **Possible consequence:** Electrical shock or fire.

Clean with a soft cloth. If it is difficult to remove stains, use water or a neutral detergent.

7.3 About the refrigerant

This product contains fluorinated greenhouse gases. Do NOT vent gases into the atmosphere.

Refrigerant type: R32

Global warming potential (GWP) value: 675

Refrigerant type: R410A

Global warming potential (GWP) value: 2087.5



NOTICE

Applicable legislation on **fluorinated greenhouse gases** requires that the refrigerant charge of the unit is indicated both in weight and CO₂ equivalent.

Formula to calculate the quantity in CO₂ equivalent tonnes: GWP value of the refrigerant × total refrigerant charge [in kg]/1000

Contact your installer for more information.



WARNING: MILDLY FLAMMABLE MATERIAL

The R32 refrigerant (if applicable) in this unit is mildly flammable. Refer to the outdoor unit specifications for the type of refrigerant to be used.



WARNING

The appliance using R32 refrigerant shall be stored so as to prevent mechanical damage and in a well-ventilated room without continuously operating ignition sources (e.g. open flames, an operating gas appliance, or an operating electric heater). The room size shall be as specified in the General safety precaution.



WARNING

- Do NOT pierce or burn refrigerant cycle parts.
- Do NOT use cleaning materials or means to accelerate the defrosting process other than those recommended by the manufacturer.
- Be aware that the refrigerant inside the system is odourless.



WARNING

- R410A is a non-combustible refrigerant, and R32 is a mildly flammable refrigerant; they normally do NOT leak. If the refrigerant leaks in the room and comes into contact with fire from a burner, a heater, or a cooker, this may result in a fire (in case of R32), or the formation of a harmful gas.
- Turn OFF any combustible heating devices, ventilate the room, and contact the dealer from where you purchased the unit.
- Do NOT use the unit until a service person confirms that the part from which the refrigerant leaked has been repaired.

8 Troubleshooting

If one of the following malfunctions occur, take the measures shown below and contact your dealer.



WARNING

Stop operation and shut OFF the power if anything unusual occurs (burning smells etc.).

Leaving the unit running under such circumstances may cause breakage, electrical shock or fire. Contact your dealer.

The system MUST be repaired by a qualified service person.

Malfunction	Measure
If a safety device such as a fuse, a circuit breaker or a residual current device frequently actuates or the ON/OFF switch does NOT function properly.	Turn OFF all main power supply switches to the unit.
If water leaks from the unit.	Stop operation.
The operation switch does NOT function properly.	Turn OFF the power supply.

9 Relocation

Malfunction	Measure
If the user interface displays 	Notify your installer and report the error code. To display an error code see the reference guide of the user interface.

INFORMATION

Refer to the reference guide located on <https://www.daikin.eu> for more troubleshooting tips. Use the search function  to find your model.

If after checking all above items, it is impossible to fix the problem yourself, contact your installer and state the symptoms, the complete model name of the unit (with manufacturing number if possible) and the installation date (possibly listed on the warranty card).

For the installer

11 About the box

11.1 Indoor unit

INFORMATION

The following figures are just examples and may NOT completely match your system layout.

WARNING: MILDLY FLAMMABLE MATERIAL

The R32 refrigerant (if applicable) in this unit is mildly flammable. Refer to the outdoor unit specifications for the type of refrigerant to be used.

11.1.1 To remove the accessories from the indoor unit

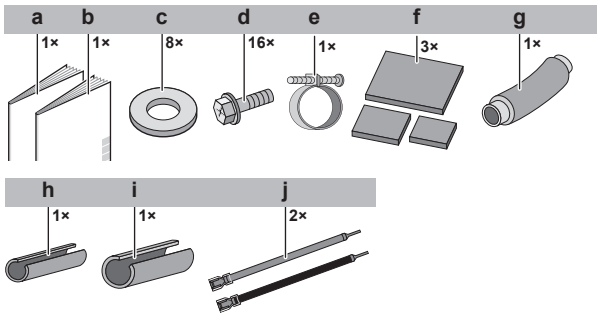

- a Installation and operation manual
- b General safety precautions
- c Washers for hanger bracket
- d Screws for duct flanges
- e Metal clamp
- f Sealing pads: Large (drain pipe), medium 1 (gas pipe), medium 2 (liquid pipe)
- g Drain hose
- h Insulation piece: Small (liquid pipe)
- i Insulation piece: Large (gas pipe)
- j Wire for common power supply

12 Unit installation

WARNING

Installation shall be done by an installer, the choice of materials and installation shall comply with the applicable legislation. In Europe, EN378 is the applicable standard.

9 Relocation

Contact your dealer to remove and reinstall the entire unit. Moving units requires technical expertise.

10 Disposal

NOTICE

Do NOT try to dismantle the system yourself: dismantling of the system, treatment of the refrigerant, oil and other parts MUST comply with applicable legislation. Units MUST be treated at a specialised treatment facility for reuse, recycling and recovery.

12.1 Preparing the installation site

WARNING

The appliance using R32 refrigerant shall be stored so as to prevent mechanical damage and in a well-ventilated room without continuously operating ignition sources (e.g. open flames, an operating gas appliance, or an operating electric heater). The room size shall be as specified in the General safety precaution.

12.1.1 Installation site requirements of the indoor unit

INFORMATION

The sound pressure level is less than 70 dBA.

- Use **suspension bolts** for installation.
- **Spacing.** Mind the following requirements:

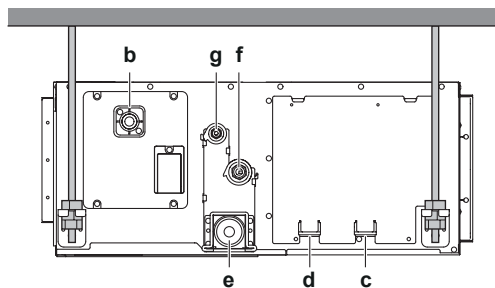
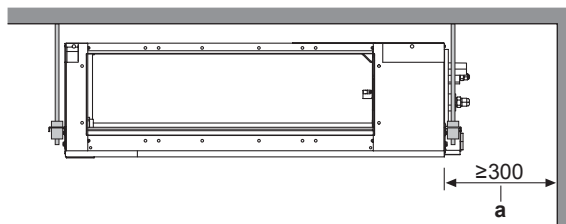

- a Service space
- b Drain pipe
- c Power supply wiring port
- d Transmission wiring port
- e Maintenance drain outlet
- f Gas pipe
- g Liquid pipe

- **Installation options:**

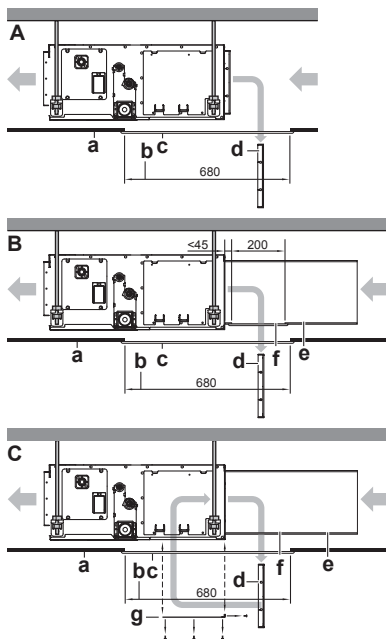

- A Standard rear suction
- B Installation with rear duct and duct service opening
- C Installation with rear duct, no duct service opening
- a Ceiling surface
- b Ceiling opening
- c Service access panel (field supply)
- d Air filter
- e Air inlet filter
- f Duct service opening
- g Interchangeable plate

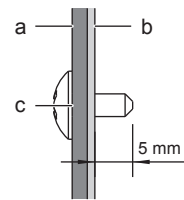

- a Air inlet duct
- b Inside of the flange
- c Fixing screw

- **Ceiling strength.** Check whether the ceiling is strong enough to support the weight of the unit. If there is a risk, reinforce the ceiling before installing the unit.

▪ **Installation options:**

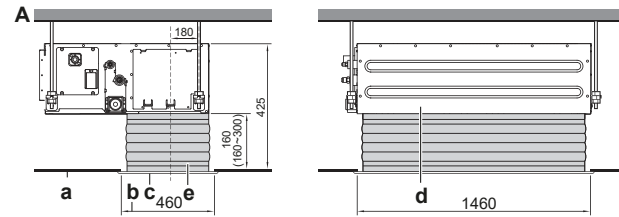

- A Mounting the air inlet with a canvas connection
- a Ceiling surface
- b Ceiling opening
- c Air inlet panel (field supply)
- d Indoor unit (back side)
- e Canvas connection for air inlet panel (field supply)



INFORMATION

The unit can be used with bottom suction by replacing the interchangeable plate by the air filter holding plate.

12.2 Mounting the indoor unit

12.2.1 Guidelines when installing the indoor unit



INFORMATION

Optional equipment. When installing optional equipment, also read the installation manual of the optional equipment. Depending on the field conditions, it might be easier to install the optional equipment first.

- **In case of installation with duct, but no duct service opening.** Modify the position of the air filters.

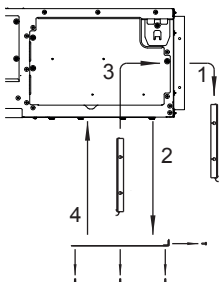

- 1 Remove the air filter(s) from the outside of the unit.
 - 2 Remove the interchangeable plate.
 - 3 Install the air filter(s) on the inside of the unit.
 - 4 Reinstall the interchangeable plate.
- When installing an air inlet duct, select fixing screws that stick out 5 mm on the inside of the flange to protect the air filter from damage during maintenance of the filter.

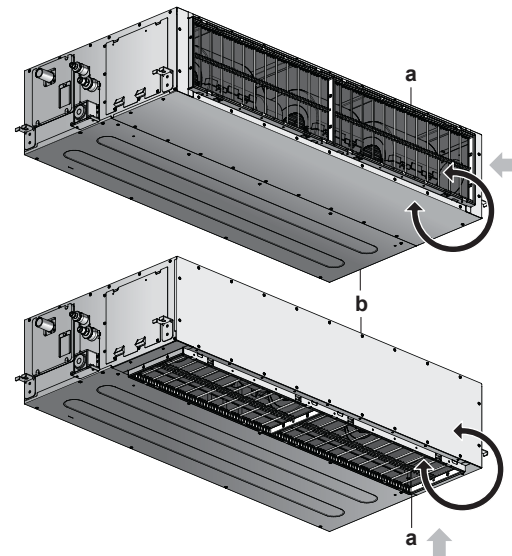

- a Air filter holding plate with air filter(s)
- b Interchangeable plate

- **Suspension bolts.** Use M10 suspension bolts for installation. Attach the hanger bracket to the suspension bolt. Fix it securely using a nut and washer from the upper and lower sides of the hanger bracket.
- **Ceiling opening size.** Make sure the ceiling opening is within the following limits:

12 Unit installation

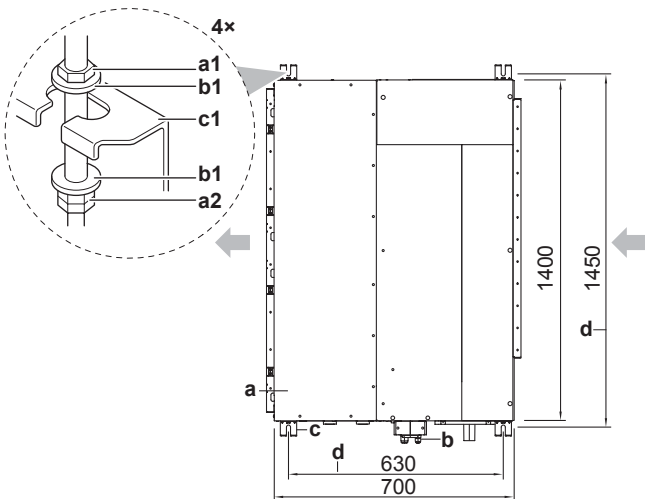

- a1 Nut (field supply)
- a2 Double nut (field supply)
- b1 Washer (accessories)
- c1 Hanger bracket (attached to the unit)
- a Indoor unit
- b Pipe
- c Hanger bracket pitch (suspension)
- d Suspension bolt spacing

Installation example:

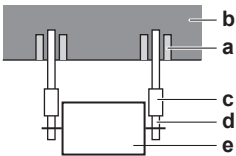

- a Anchor
- b Ceiling slab
- c Long nut or turn-buckle
- d Suspension bolt
- e Indoor unit

Install the unit temporarily.

- 5 Attach the hanger bracket to the suspension bolt.
 - 6 Fix it securely.
- **Level.** Make sure the unit is level at all four corners using a level or a water-filled vinyl tube.

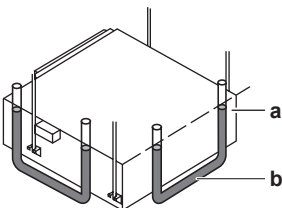

- a Water level
- b Vinyl tube

- 7 Tighten the upper nut.

NOTICE

Do NOT install the unit tilted. **Possible consequence:** If the unit is tilted against the direction of the condensate flow (the drain piping side is raised), the float switch might malfunction and cause water to drip.

12.2.2 Guidelines when installing the ducting

WARNING

Do NOT install operating ignition sources (example: open flames, an operating gas appliance or an operating electric heater) in the duct work.

CAUTION

- Make sure the installation of the duct does NOT exceed the setting range of the external static pressure for the unit. Refer to the technical datasheet of your model for the setting range.
- Make sure to install the canvas duct so vibrations are NOT transmitted to the duct or ceiling. Use a sound-absorbing material (insulation material) for the lining of the duct and apply vibration insulation rubber to the hanging bolts.
- When welding, make sure NOT to spatter onto the drain pan or the air filter.
- If the metal duct passes through a metal lath, wire lath or metal plate of the wooden structure, separate the duct and wall electrically.
- Install the outlet grille in a position where the airflow will not come into direct contact with people.
- Do NOT use booster fans in the duct. Use the function to adjust the fan rate setting automatically (see "16 Configuration" [p 19]).

The ducting is to be field supplied.

- **Air inlet side.** Attach the duct and intake-side flange (field supply). For connecting the flange, use 7 accessory screws.

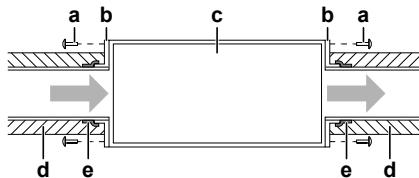

- a Connection screw (accessory)
- b Flange (field supply)
- c Main unit
- d Insulation (field supply)
- e Aluminium tape (field supply)

- **Fixing screws.** When installing an air inlet duct, select fixing screws that stick out 5 mm on the inside of the flange to protect the air filter from damage during maintenance of the filter.

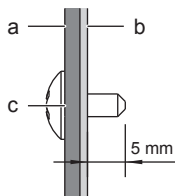

- a Air inlet duct
- b Inside of the flange
- c Fixing screw

- **Filter.** Be sure to attach an air filter inside the air passage on the intake side. Use an air filter with dust collecting efficiency $\geq 50\%$ (gravimetric method). The included filter is not used when the intake duct is attached.
- **Air outlet side.** Connect the duct according to the inside dimension of the outlet-side flange.
- **Air leaks.** Wind aluminium tape around the intake side flange and duct connection. Make sure there are no air leaks at any other connection.
- **Insulation.** Insulate the duct to prevent condensation from forming. Use glass wool or polyethylene foam 25 mm thick.

12.2.3 Guidelines when installing the drain piping

Make sure condensation water can be evacuated properly. This involves:

- General guidelines
- Connecting the drain piping to the indoor unit
- Checking for water leaks

General guidelines

- **Drain pump.** For this "high lift type", the drainage sounds will be reduced when the drain pump is installed in a higher location. Recommended height is 300 mm.
- **Pipe length.** Keep drain piping as short as possible.
- **Pipe size.** Keep the pipe size equal to or greater than that of the connecting pipe (vinyl pipe of 20 mm nominal diameter and 26 mm outer diameter).
- **Slope.** Make sure the drain piping slopes down (at least 1/100) to prevent air from being trapped in the piping. Use hanging bars as shown.

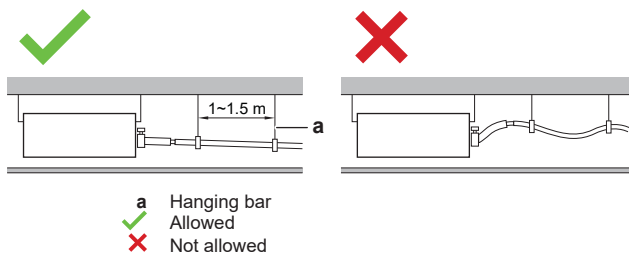

- **Condensation.** Take measures against condensation. Insulate the complete drain piping in the building.
- **Rising piping.** If necessary to make the slope possible, you can install rising piping.
 - Drain hose inclination: 0~75 mm to avoid stress on the piping and to avoid air bubbles.
 - Rising piping: ≤300 mm from the unit, ≤625 mm perpendicular to the unit.

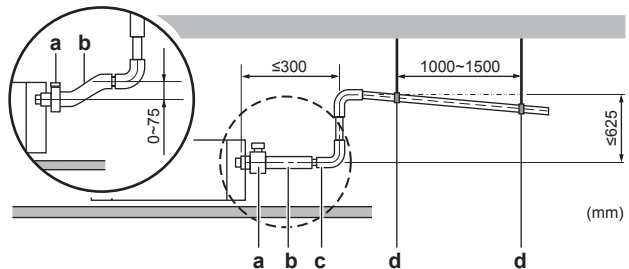

- a Metal clamp (accessory)
- b Drain hose (accessory)
- c Rising drain piping (vinyl pipe of 25 mm nominal diameter and 32 mm outer diameter) (field supply)
- d Hanging bars (field supply)

- **Combining drain pipes.** You can combine drain pipes. Make sure to use drain pipes and T-joints with the correct gauge for the operating capacity of the units.

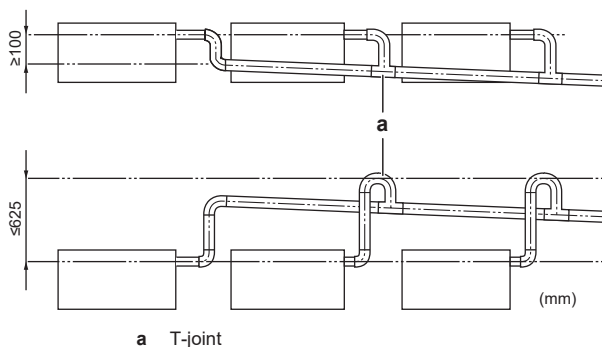

To connect the drain piping to the indoor unit



NOTICE

Incorrect connection of the drain hose might cause leaks, and damage the installation space and surroundings.

- 1 Push the drain hose as far as possible over the drain pipe connection.
- 2 Tighten the metal clamp until the screw head is less than 4 mm from the metal clamp part.
- 3 Check for water leaks (see "To check for water leaks" [▶ 16]).
- 4 Install the insulation piece (drain pipe).
- 5 Wind the large sealing pad (= insulation) around the metal clamp and drain hose, and fix it with cable ties.
- 6 Connect the drain piping to the drain hose.

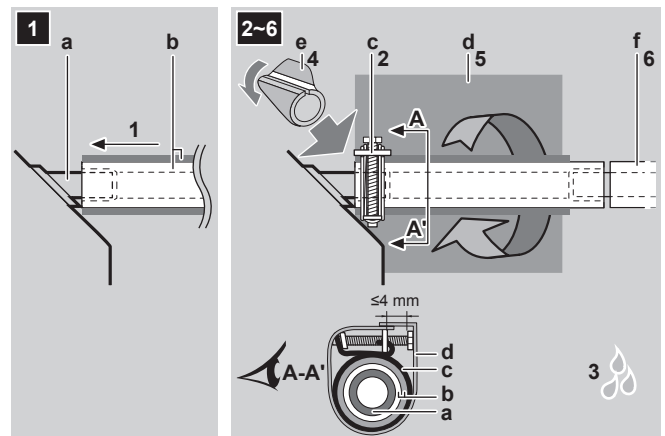

- a Drain pipe connection (attached to the unit)
- b Drain hose (accessory)
- c Metal clamp (accessory)
- d Large sealing pad (accessory)
- e Insulation piece (drain pipe) (accessory)
- f Drain piping (field supply)



NOTICE

- Do NOT remove the drain pipe plug. Water might leak out.
- Use the drain outlet only to discharge the water if the drain pump is not used or before maintenance.
- Insert and remove the drain plug gently. Excessive force may deform the drain socket of the drain pan.

Pull out the plug.

- Do NOT wiggle the plug up and down.

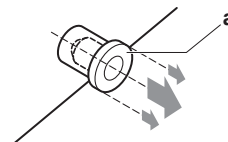

Push in the plug.

- Set the plug and push it in using a Phillips screwdriver.

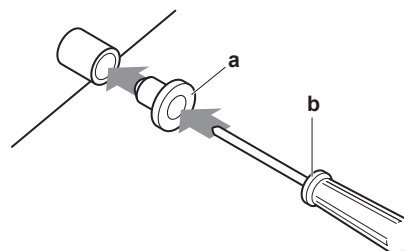

- a Drain plug
- b Philips screwdriver

13 Piping installation

To check for water leaks

The procedure differs depending on whether electrical wiring is already finished. When electrical wiring is not finished yet, you need to temporarily connect the user interface and power supply to the unit.

When installation of the system is not yet completed

- 1 Temporarily connect electrical wiring.
- 2 Remove the switch box cover (a).
- 3 Connect the single-phase power supply (50 Hz, 230 V) to connections No. 1 and No. 2 on the terminal block for power supply and earth.
- 4 Reattach the switch box cover (a).
- 5 Turn ON the power.
- 6 Start cooling operation (see "15.2 To perform a test run" ▶ 19).
- 7 Gradually pour approximately 1 l of water through the air discharge outlet, and check for leaks.

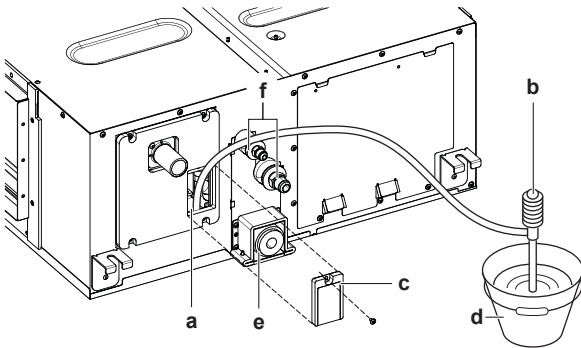

- a Water inlet
- b Portable pump
- c Water inlet cover
- d Bucket (adding water through water inlet)
- e Drain outlet for maintenance
- f Refrigerant pipes

- 8 Turn OFF the power.
- 9 Disconnect the electrical wiring.
- 10 Remove the control box cover.
- 11 Disconnect the power supply and earth.
- 12 Reattach the control box cover.

When installation of the system is already completed

- 1 Start cooling operation (see the reference guide or the service manual of the user interface).
- 2 Gradually pour approximately 1 l of water through the water inlet, and check for leaks (see "When installation of the system is not yet completed" ▶ 16).

13 Piping installation

13.1 Preparing refrigerant piping

13.1.1 Refrigerant piping requirements



CAUTION

Piping **MUST** be installed according to instructions given in "13 Piping installation" ▶ 16]. Only mechanical joints (e.g. braze+flare connections) that are compliant with the latest version of ISO14903 can be used.



NOTICE

The piping and other pressure-containing parts shall be suitable for refrigerant. Use phosphoric acid deoxidised seamless copper for refrigerant piping.

- Foreign materials inside pipes (including oils for fabrication) must be ≤ 30 mg/10 m.

Refrigerant piping diameter

For piping connections of the indoor unit, use the following piping diameters:

Pipe outer diameter (mm)	
Liquid pipe	Gas pipe
Ø9.5	Ø15.9

Refrigerant piping material

- Piping material:** phosphoric acid deoxidised seamless copper
- Flare connections:** Only use annealed material.
- Piping temper grade and thickness:**

Outer diameter (Ø)	Temper grade	Thickness (t) ^(a)	
9.5 mm (3/8")	Annealed (O)	≥0.8 mm	
15.9 mm (5/8")	Annealed (O)		

^(a) Depending on the applicable legislation and the maximum working pressure of the unit (see "PS High" on the unit name plate), larger piping thickness might be required.

13.1.2 Refrigerant piping insulation

- Use polyethylene foam as insulation material:
 - with a heat transfer rate between 0.041 and 0.052 W/mK (0.035 and 0.045 kcal/mh°C)
 - with a heat resistance of at least 120°C
- Insulation thickness

Pipe outer diameter (Ø _p)	Insulation inner diameter (Ø _i)	Insulation thickness (t)
9.5 mm (3/8")	10~14 mm	≥13 mm
15.9 mm (5/8")	16~20 mm	≥13 mm

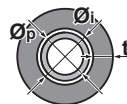

If the temperature is higher than 30°C and the humidity is higher than RH 80%, the thickness of the insulation materials should be at least 20 mm to prevent condensation on the surface of the insulation.

13.2 Connecting the refrigerant piping



DANGER: RISK OF BURNING/SCALDING

13.2.1 To connect the refrigerant piping to the indoor unit



CAUTION

Install the refrigerant piping or components in a position where they are unlikely to be exposed to any substance which may corrode components containing refrigerant, unless the components are constructed of materials that are inherently resistant to corrosion or are suitably protected against corrosion.

WARNING: MILDLY FLAMMABLE MATERIAL

The R32 refrigerant (if applicable) in this unit is mildly flammable. Refer to the outdoor unit specifications for the type of refrigerant to be used.

- **Pipe length.** Keep refrigerant piping as short as possible.
- **Flare connections.** Connect refrigerant piping to the unit using flare connections.
- **Insulation.** Insulate the refrigerant piping on the indoor unit as follows:

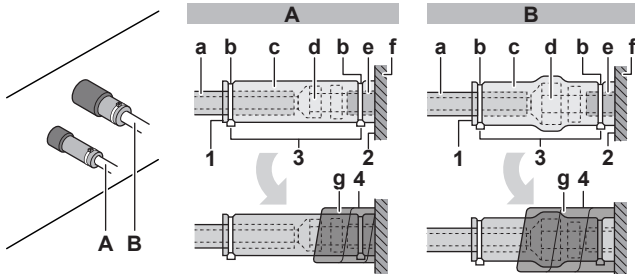

- A Liquid piping
 - B Gas piping
 - a Insulation material (field supply)
 - b Tie wrap (field supply)
 - c Insulation pieces: Large (gas pipe), small (liquid pipe) (accessories)
 - d Flare nut (attached to the unit)
 - e Refrigerant pipe connection (attached to the unit)
 - f Unit
 - g Sealing pads: Medium 1 (gas pipe), medium 2 (liquid pipe) (accessories)
- 1 Turn up the seams of the insulation pieces.
 - 2 Attach to the base of the unit.
 - 3 Tighten the tie wrap on the insulation pieces.
 - 4 Wrap the sealing pad from the base of the unit to the top of the flare nut.

NOTICE

Make sure to insulate all refrigerant piping. Any exposed piping might cause condensation.

14 Electrical installation

DANGER: RISK OF ELECTROCUTION

WARNING

ALWAYS use multicore cable for power supply cables.

WARNING

Use an all-pole disconnection type breaker with at least 3 mm between the contact point gaps that provides full disconnection under overvoltage category III.

WARNING

If the supply cord is damaged, it MUST be replaced by the manufacturer, its service agent or similarly qualified persons in order to avoid a hazard.

WARNING

Prevent hazards due to inadvertent resetting of the thermal cut-out: power to this appliance MUST NOT be supplied through an external switching device, such as a timer, or connected to a circuit that is regularly turned ON and OFF by the utility.

14.1 Specifications of standard wiring components

NOTICE

We recommend using solid (single-core) wires. If stranded wires are used, slightly twist the strands to consolidate the end of the conductor for either direct use in the terminal clamp or insertion in a round crimp-style terminal. Details are described in "Guidelines when connecting the electrical wiring" in the installer reference guide.

Component		FDA125A
Power supply cable	MCA ^(a)	2.1 A
	Voltage	220~240 V
	Current	2.1 A
	Phase	1~
	Frequency	50/60 Hz
	Wire sizes	MUST comply with national wiring regulation. 3-core cable Wire size based on the current, but not less than 2.5 mm ²
Interconnection cable (indoor↔outdoor)	Voltage	220~240 V
	Wire size	Only use harmonised wire providing double insulation and suitable for applicable voltage. 4-core cable Minimum 1.5 mm ²
User interface cable	Wire size	Only use harmonised wire providing double insulation and suitable for applicable voltage 2-core wire
	Wire length	Maximum 500 m
Recommended field fuse		16 A
Earth leakage circuit breaker / residual current device		MUST comply with national wiring regulation

^(a) MCA=Minimum circuit ampacity. Stated values are maximum values (see electrical data of indoor unit for exact values).

14.2 To connect the electrical wiring to the indoor unit

NOTICE

- Follow the wiring diagram (delivered with the unit, located on the switch box cover).
- Make sure the electrical wiring does NOT obstruct proper reattachment of the service cover.

It is important to keep the power supply and the transmission wiring separated from each other. In order to avoid any electrical interference the distance between both wirings should ALWAYS be at least 50 mm.

NOTICE

Be sure to keep the power line and transmission line apart from each other. Transmission wiring and power supply wiring may cross, but may NOT run parallel.

- 1 Remove the service cover.
- 2 **User interface cable:** Route the cable through the frame, connect the cable to the terminal block, and fix the cable with a cable tie.

15 Commissioning

- 3 **Interconnection cable** (indoor↔outdoor): Route the cable through the frame, connect the cable to the terminal block (make sure the numbers match with the numbers on the outdoor unit, and connect the earth wire), and fix the cable with a cable tie.
- 4 Divide the small sealing (accessory) and wrap it around the cables to prevent water from entering the unit. Seal all gaps to prevent small animals from entering the system.
- 5 Reattach the service cover.

• **When using 1 user interface with 1 indoor unit.**

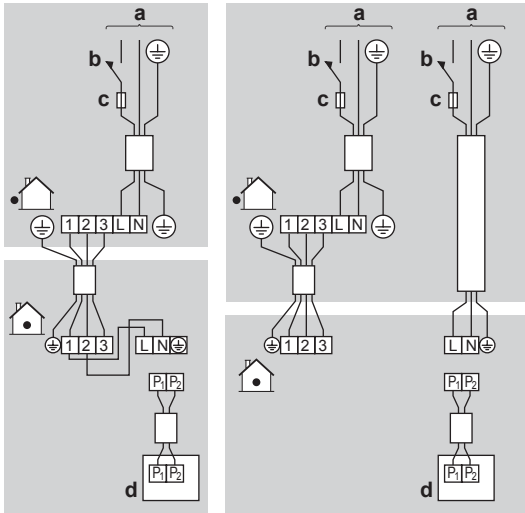

• **When using 2 user interfaces⁽¹⁾**

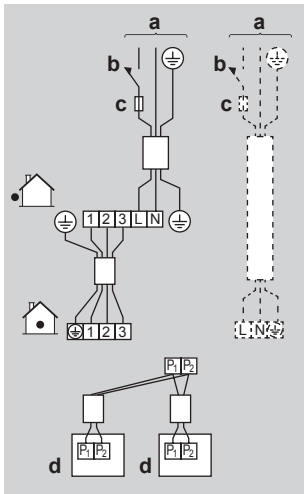

• **When using group control⁽¹⁾**

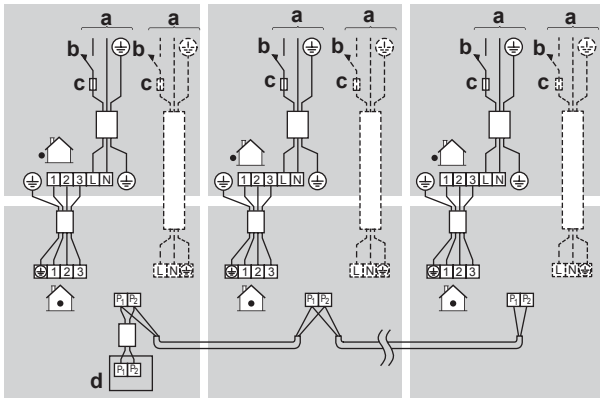

a Power supply
b Main switch

⁽¹⁾ Dashed line represents separate power supply.

c Fuse
d User interface

- **Master unit:** Be sure to connect the wiring when combining with a simultaneously operating multi-type in group control.

i **INFORMATION**

In case of group control, it is not necessary to assign a group address to the indoor unit. The group address is automatically set when the power is turned on.

- **EN/IEC 61000-3-12** provided that the short-circuit power S_{sc} is greater than or equal to the minimum S_{sc} value at the interface point between the user's supply and the public system.

- EN/IEC 61000-3-12 = European/International Technical Standard setting the limits for harmonic currents produced by equipment connected to public low-voltage systems with input current >16 A and ≤75 A per phase.

- It is the responsibility of the installer or user of the equipment to ensure, by consultation with the distribution network operator if necessary, that the equipment is connected ONLY to a supply with a short-circuit power S_{sc} greater than or equal to the minimum S_{sc} value.

To comply with EN/IEC 61000-3-12, following rules must be considered:

- In case of combination of units 2x FDA125A + RZQ250, use separate power supplies.

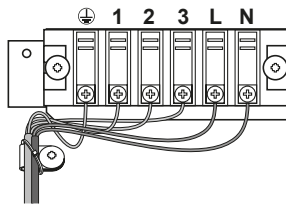

- Otherwise, refer to the table with S_{sc} values for FDA125A on the extranet.

- If the S_{sc} value is NOT mentioned in the table for the used combination, use the common power supply wire delivered with the unit.

- If the S_{sc} value is mentioned in the table, both the common power supply wire or a separate power supply can be used, but a separate power supply is preferred.

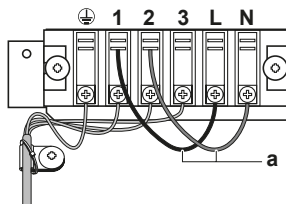

a Wire for common power supply (accessory)

15 Commissioning

! **NOTICE**

General commissioning checklist. Next to the commissioning instructions in this chapter, a general commissioning checklist is also available on the Daikin Business Portal (authentication required).

The general commissioning checklist is complementary to the instructions in this chapter and can be used as a guideline and reporting template during commissioning and hand-over to the user.

**NOTICE**

ALWAYS operate the unit with thermistors and/or pressure sensors/switches. If NOT, burning of the compressor might be the result.

15.1 Checklist before commissioning

- 1 After the installation of the unit, check the items listed below.
- 2 Close the unit.
- 3 Power up the unit.

<input type="checkbox"/>	You have read the complete installation and operation instructions described in the installer and user reference guide .
<input type="checkbox"/>	The indoor unit is properly mounted.
<input type="checkbox"/>	The outdoor unit is properly mounted.
<input type="checkbox"/>	The drain piping is properly installed and insulated, and drainage flows smoothly. Check for water leaks. Possible consequence: condensate water might drip.
<input type="checkbox"/>	The ducting is properly installed and insulated.
<input type="checkbox"/>	The refrigerant pipes (gas and liquid) are installed correctly and thermally insulated.
<input type="checkbox"/>	There are NO refrigerant leaks .
<input type="checkbox"/>	There are NO missing phases or reversed phases .
<input type="checkbox"/>	The system is properly earthed and the earth terminals are tightened.
<input type="checkbox"/>	The fuses or locally installed protection devices are installed according to this document, and have NOT been bypassed.
<input type="checkbox"/>	The power supply voltage matches the voltage on the identification label of the unit.
<input type="checkbox"/>	There are NO loose connections or damaged electrical components in the switch box.
<input type="checkbox"/>	There are NO damaged components or squeezed pipes on the inside of the indoor and outdoor units.
<input type="checkbox"/>	The stop valves (gas and liquid) on the outdoor unit are fully open.

15.2 To perform a test run**INFORMATION**

- Perform the test run according to the instructions in the connected user interface manual.
- The test run is only completed if there is no malfunction code displayed on the user interface.
- See the service manual for the complete list of error codes and a detailed troubleshooting guideline for each error.

**NOTICE**

Do NOT interrupt the test run.

16 Configuration**16.1 Field setting**

Make the following field settings so that they correspond with the actual installation setup and with the needs of the user:

- External static pressure setting using:
 - Airflow automatic adjustment setting
 - User interface
- Time to clean air filter

To set airflow automatic adjustment

- When the air conditioning unit is running in fan operation mode:

- 1 Stop the air conditioning unit.
- 2 Set value number / second code number to 03.

Setting content:	Then ⁽¹⁾		
	M	C1/ SW	C2/ —
Airflow adjustment is OFF	11(21)	7	01
Press ON/OFF to return to normal operating mode.			03
Possible consequence: The operation lamp will light up and the unit will start the fan operation for airflow automatic adjustment.			
Operation stops after 1 to 8 minutes.			02
Possible consequence: Setting is finished and the operation lamp will be off.			

If there is no change after airflow adjustment, perform the setting again.

**INFORMATION**

- The fan speed of the indoor unit is preset to ensure the standard external static pressure.
- To set a higher or lower external static pressure, reset the initial setting with the user interface.

User interface

Check the indoor unit setting: the value number / second code number of mode 11(21) must be set to 01.

Change the value number / second code number according to the external static pressure of the duct to be connected as in table below.

⁽¹⁾ Field settings are defined as follows:

- **M**: Mode number – **First number**: for group of units – **Number between brackets**: for individual unit
- **SW**: Setting number / **C1**: First code number
- **—**: Value number / **C2**: Second code number
- **■**: Default

17 Technical data

M	C1/SW	C2/—	External static pressure ⁽¹⁾
13(23)	6	01	40
		02	50
		03	60
		04	70
		05	80
		06	90
		07	100
		08	110
		09	120
		10	130
		11	140
		12	150
		13	160
		14	180
		15	200

Time to clean air filter

This setting must correspond with the air contamination in the room. It determines the interval at which the **TIME TO CLEAN AIR FILTER** notification is displayed on the user interface. When using a wireless user interface, you must also set the address (see the installation manual of the user interface).

If you want an interval of... (air contamination)	ThenFN		
	M	C1/SW	C2/—
±2500 h (light)	10(20)	0	01
±1250 h (heavy)			02
No notification		3	02

- **2 user interfaces:** When using 2 user interfaces, one must be set to "MAIN" and the other to "SUB".







17 Technical data











- A **subset** of the latest technical data is available on the regional Daikin website (publicly accessible).
- The **full set** of latest technical data is available on the Daikin Business Portal (authentication required).

17.1 Wiring diagram

17.1.1 Unified wiring diagram legend

For applied parts and numbering, refer to the wiring diagram on the unit. Part numbering is by Arabic numbers in ascending order for each part and is represented in the overview below by "*" in the part code.

Symbol	Meaning	Symbol	Meaning
	Circuit breaker		Protective earth
	Connection		Protective earth (screw)
	Connector		Rectifier

Symbol	Meaning	Symbol	Meaning
	Earth		Relay connector
	Field wiring		Short-circuit connector
	Fuse		Terminal
	Indoor unit		Terminal strip
	Outdoor unit		Wire clamp
	Residual current device		

Symbol	Colour	Symbol	Colour
BLK	Black	ORG	Orange
BLU	Blue	PNK	Pink
BRN	Brown	PRP, PPL	Purple
GRN	Green	RED	Red
GRY	Grey	WHT	White
SKY BLU	Sky blue	YLW	Yellow

Symbol	Meaning
A*P	Printed circuit board
BS*	Pushbutton ON/OFF, operation switch
BZ, H*O	Buzzer
C*	Capacitor
AC*, CN*, E*, HA*, HE*, HL*, HN*, HR*, MR*_A, MR*_B, S*, U, V, W, X*A, K*R_*, NE	Connection, connector
D*, V*D	Diode
DB*	Diode bridge
DS*	DIP switch
E*H	Heater
FU*, F*U, (for characteristics, refer to PCB inside your unit)	Fuse
FG*	Connector (frame ground)
H*	Harness
H*P, LED*, V*L	Pilot lamp, light emitting diode
HAP	Light emitting diode (service monitor green)
HIGH VOLTAGE	High voltage
IES	Intelligent eye sensor
IPM*	Intelligent power module
K*R, KCR, KFR, KHuR, K*M	Magnetic relay
L	Live
L*	Coil
L*R	Reactor
M*	Stepper motor
M*C	Compressor motor
M*F	Fan motor
M*P	Drain pump motor
M*S	Swing motor
MR*, MRCW*, MRM*, MRN*	Magnetic relay
N	Neutral

⁽¹⁾ Field settings are defined as follows:

- **M:** Mode number – **First number:** for group of units – **Number between brackets:** for individual unit
- **SW:** Setting number / **C1:** First code number
- **—:** Value number / **C2:** Second code number
- : Default

Symbol	Meaning
n=*, N=*	Number of passes through ferrite core
PAM	Pulse-amplitude modulation
PCB*	Printed circuit board
PM*	Power module
PS	Switching power supply
PTC*	PTC thermistor
Q*	Insulated gate bipolar transistor (IGBT)
Q*C	Circuit breaker
Q*DI, KLM	Earth leak circuit breaker
Q*L	Overload protector
Q*M	Thermo switch
Q*R	Residual current device
R*	Resistor
R*T	Thermistor
RC	Receiver
S*C	Limit switch
S*L	Float switch
S*NG	Refrigerant leak detector
S*NPH	Pressure sensor (high)
S*NPL	Pressure sensor (low)
S*PH, HPS*	Pressure switch (high)
S*PL	Pressure switch (low)
S*T	Thermostat
S*RH	Humidity sensor
S*W, SW*	Operation switch
SA*, F1S	Surge arrester
SR*, WLU	Signal receiver
SS*	Selector switch
SHEET METAL	Terminal strip fixed plate
T*R	Transformer
TC, TRC	Transmitter
V*, R*V	Varistor
V*R	Diode bridge, Insulated-gate bipolar transistor (IGBT) power module
WRC	Wireless remote controller
X*	Terminal
X*M	Terminal strip (block)
Y*E	Electronic expansion valve coil
Y*R, Y*S	Reversing solenoid valve coil
Z*C	Ferrite core
ZF, Z*F	Noise filter





ERC



Copyright 2017 Daikin